



Revestimiento de liners en PVC

La mejor solución para la estanquidad de la piscina

PVC Liners

The best solution for a watertight pool



ASTRALPOOL



Revestimiento de liners en PVC

PVC Liners

Personalice su piscina con liners de máxima garantía y confianza

AstralPool le ofrece la mayor gama de liners para que usted dé una imagen especial y única a su piscina. Puede vestir su piscina con un revestimiento de fondo liso o estampado, o puede combinar estas dos opciones con cenefas.

Fabricados en PVC-P reforzado (policloruro de vinilo plastificado) es el material más usado para el revestimiento de piscinas por su gran maleabilidad, resistencia al desgarro, facilidad en la soldadura, resistencia a la decoloración por los rayos UV y por su amplia gama de colores disponibles.

Nuestros liners se ajustarán perfectamente a cualquier diseño o forma de piscina, creando una perfecta estanqueidad y así poder olvidarnos de las molestas fugas de agua.

Características del liner:

- Para su fabricación se utiliza el PVC, un polímero completamente reciclable cuyas principales materias primas son el petróleo y cloruro sódico.
- Para darle las propiedades químicas y mecánicas se utilizan los aditivos que están hoy en día legislados por normativas internacionales y por la carta de compromiso de fabricantes. En la actualidad está prohibida la utilización de compuestos de Cadmio, y en el año 2010 está prevista la prohibición de usar compuestos que incluyan Plomo.
- El PVC no forma dioxinas en la atmósfera, y a través de la degasificación tipo "Lindel" puede ser reciclado perfectamente. El liner de las piscinas se reutiliza normalmente para la construcción de suelos técnicos.



Customise your pool with liners that ensure maximum guarantee and reliability

AstralPool offers you the widest range of liners to ensure a unique look for your pool. You can choose between a plain or patterned liner, or you can combine the two options by incorporating frieze borders.

Manufactured in reinforced PVC-P, this material is the most used for lining pools thanks to enhanced malleability, resistance to tearing, ease of welding, resistance to fading by UV rays and with a wide range of available colours.

Our liners are perfectly adaptable to any pool design or shape, with excellent watertight features, so you can forget about annoying leaks.

Liner characteristics:

- We use a fully recyclable polymer made from petroleum and sodium chloride.
- Chemical and mechanical properties are provided by additives that comply with international standards and the Manufacturer's Letter of Commitment. The use of cadmium compounds is currently forbidden and, in 2010, lead-based compounds will be forbidden.
- PVC does not release dioxins into the atmosphere and can be recycled by means of Lindell type degasification. Pool liner is normally reused for technical construction.



Máxima adaptabilidad

Nuestros liners son adaptables a todo tipo de piscinas tanto de uso privado como público. Además están completamente garantizados a una total estanqueidad. Toda una inversión de futuro para su piscina.

Maximum adaptability

Our liners can be fitted to all types of pool for both public and private use. They are also fully guaranteed for total watertightness. A real investment for the future of your pool.

Amplia gama

AstralPool le ofrece la mayor variedad de colores, estampados y cenefas para que usted le dé un toque personal a su piscina.

Wide range

AstralPool offers you a great variety of colours, patterns and frieze borders so that you can lend a personal touch to your pool.

Fácil instalación

Podrá colocar su nuevo liner o sustituir el existente de manera rápida y segura. Este se coloca gracias a un sistema de fijación mediante un perfil de sujeción que le facilitará el cambio de liner en cualquier momento, sin necesidad de levantar la piedra de coronación en el caso de piscinas ya construidas.

Easy-to-install

Lay your new liner or replace the existing one easily and securely thanks to a fastening system that will help you change the liner at any time. You don't need to raise the stone surround if the pool is already built.

Revestimiento liner 75/100

Liner 75/100

Ideal para piscinas privadas y de uso particular. Confeccionado a medida mediante soldaduras de alta frecuencia en nuestras instalaciones, se adaptará perfectamente a su piscina. Sólo tendrá que facilitarnos las medidas de esta y AstralPool le fabricará el liner que usted precisa.

Características principales

- Resistente y estanco. El liner AstralPool está fabricado en policloruro de vinilo de gran resistencia (grueso 0,75 mm) que asegura la total estanqueidad de su piscina.
- De superficie lisa y agradable al tacto, permitirá que su mantenimiento sea fácil, cómodo y más duradero.
- Gran flexibilidad, permitiendo una gran adaptabilidad.
- Altamente resistente a golpes y desgarros.

Ideal for private pools. Made-to-measure and put together by high frequency welding at our facilities, this liner will fit your pool perfectly. Just provide us with the pool measurements and AstralPool will manufacture the liner you require.

Main features

- Resistant and watertight. AstralPool liner is manufactured from highly resistant PVC (0.75 mm thick) that ensures total watertightness for your pool.
- Smooth and pleasant to touch, it is easy to maintain and highly durable.
- Highly flexible and adaptable.
- Highly resistant to shock and tearing.

Gama de colores lisos

Range of solid colours

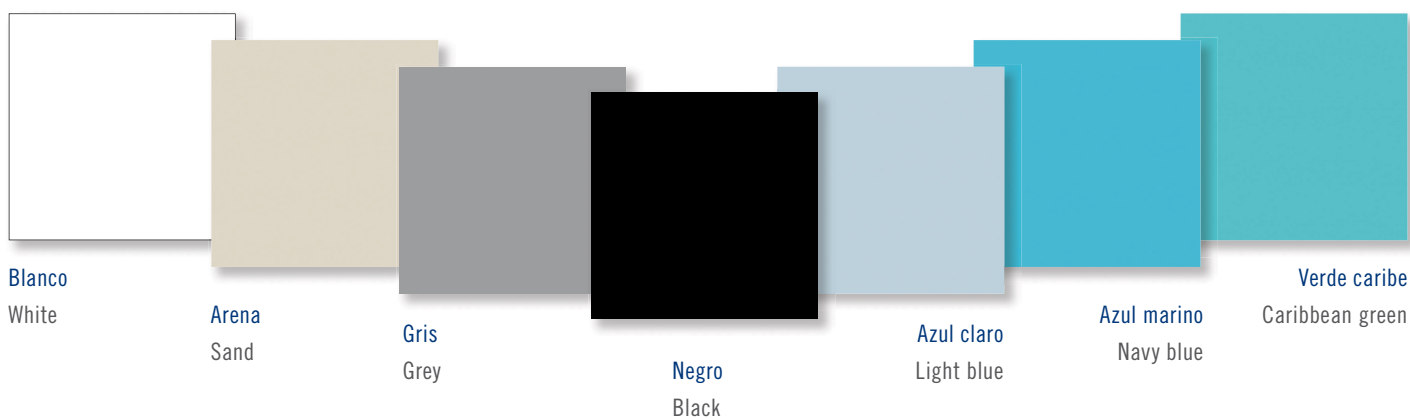

Gama de colores estampados / Range of patterned colours

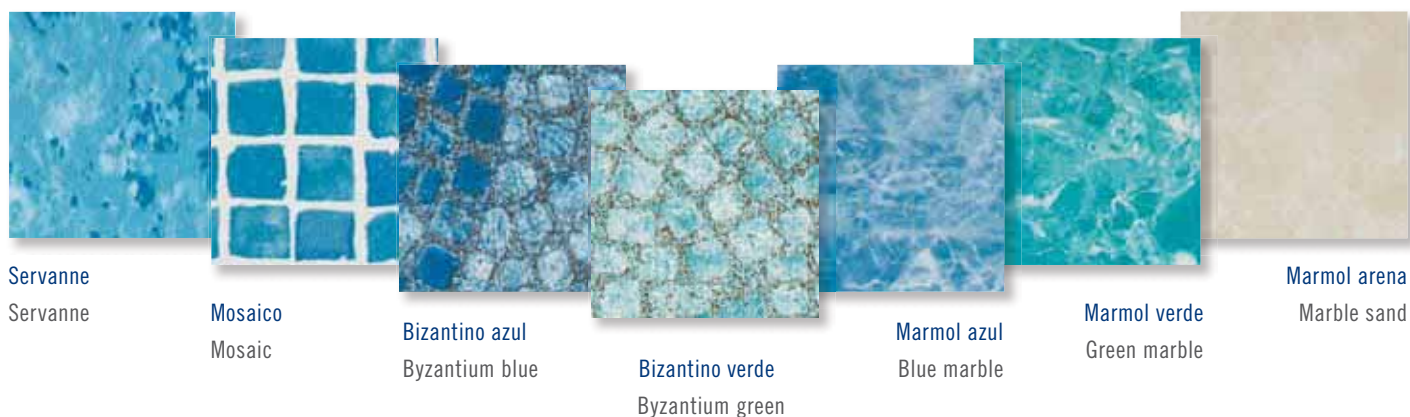

Cenefas para liners 75/100
Frieze borders for liners 75/100



Cartago azul
 Carthage blue



Cartago ocre
 Carthage ochre



Cartago verde
 Carthage green



Pompeya verde
 Pompeii green



Pompeya ocre
 Pompeii ochre



Pompeya azul
 Pompeii blue



Mikonos azul
 Mykonos blue



Mikonos ocre
 Mykonos ochre



Mikonos verde
 Mykonos green



Olympia verde
 Olympia green



Olympia ocre
 Olympia ochre



Olympia azul
 Olympia blue



Florentina
 Florentine



Sebastian
 Sebastian



Benedicta. Altura 31,5 cm.
 Benedicta. Height 31,5 cm.



Rocas
 Rocas

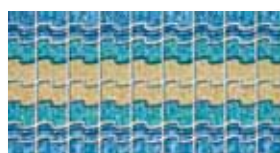

Boreal
 Boreal



Navalon azul
 Navalon blue



Colonia azul
 Cologne blue



Colonia verde
 Cologne green



Castile azul
 Castile blue



Castile verde
 Castile green



Alegro azul
 Allegro blue



Alegro verde
 Allegro green

Revestimiento liner 75/100

Liner 75/100

Muros estampados

Los muros estampados con cenefas miden 115 cm. Si la altura de los muros es superior a 115 cm, el liner será de continuidad blanco o de la continuidad presentada en esta página.



Wyndham

Liner de continuidad Blanco
Liner extension white

Patterned walls

Patterned walls with frieze borders measure 115 cm. If walls are over 115 cm high, the extension liner will be white or as shown on this page.



Lexington Wall

Liner de continuidad Beach
Liner extension Beach



Lanshire Wall

Liner de continuidad Beach
Liner extension Beach



Caribbe

Liner de continuidad
Liner extension



Dakota

Liner de continuidad
Liner extension

Clasificación de los liners según piscina

Dependiendo del modelo de piscina que disponga o vaya a construir, AstralPool ha confeccionado una clasificación de piscinas dependiendo de su forma, para que la elección del liner a colocar se realice de forma rápida y correcta.













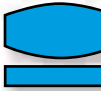

Liner classification according to pool

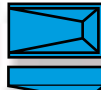





According to the pool you already have or are about to build, AstralPool can offer you a pool classification based on shape to ensure that you choose your liner quickly and correctly.

Para un buen cálculo del liner de su piscina, recomendamos se ponga en contacto con un distribuidor AstralPool. Esta operación es indispensable para una correcta instalación y evitar posibles problemas de montaje.



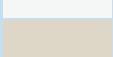

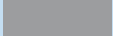
We recommend you contact your AstralPool distributor to ensure that your liner is calculated accurately. This operation is essential for correct installation and to avoid any difficulties of assembly.

Liners piscina Standard / Standard pool liners

Rectangulares / Rectangular			Circulares / Circular	Ovalados / Oval	Ovoides / Ovoid
					
					
					

Modelos lisos / Plain models		Código / Code
	Azul Claro / Light Blue	09278
	Azul Marino / Navy Blue	09277
	Verde Caribe / Caribbean green	09281
	Blanco / White	09279
	Arena / Sand	16131
	Negro / Black	085300
	Gris / Grey	085302

Modelos estampados / Patterned Models		Código / Code
	Servana	26668
	Mosaico / Mosaic	09280
	Mármol azul / Blue marble	16132
	Mármol verde / Green marble	16132V
	Mármol arena / Sand marble	16132A
	Byzantino azul / Byzantium blue	26669
	Byzantino verde / Byzantium green	26670

Muros estampados / Patterned Walls		Código / Code
	Lankshire Wall	26672
	Wyndham	26673
	Lexington Wall	26674
	Caribe / Caribbean	26676
	Dacota	26677



Recomendaciones del Dr. Pool

- Para la realización de liners con paredes estampadas, sea el caso de una piscina standard, fuera standard o forma libre, recomendamos una altura máxima de profundidad de baño de 1,10m al fin de evitar una antiestética soldadura horizontal.



Tips from Dr. Pool





- For liners with patterned walls—for a standard, non-standard or free form pool—, we recommend a maximum height for bathing of 1.10 m, so as to avoid an unsightly horizontal seam.

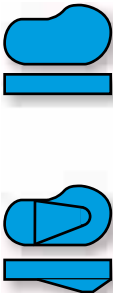
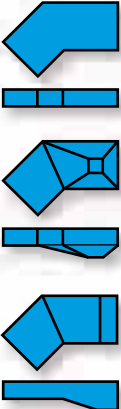
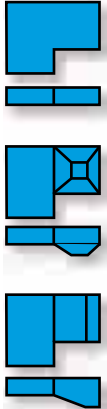

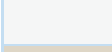
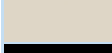

Revestimiento liner 75/100

Liner 75/100

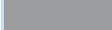
Liners piscina fuera Standard / Liners for non-standard pools

Kidney / Riñón	Lazy	Polygon / Polígono	Parallelogram / Paralelogramo	Trapezium / Trapecio
				

Modelos lisos / Plain Models		Código / Code
	Azul Claro / Light Blue	05810
	Azul Marino / Navy Blue	05809
	Verde Caribe / Caribbean green	05813
	Blanco / White	05811
	Arena / Sand	16137
	Negro / Black	089075
	Gris / Grey	089076

Modelos estampados / Patterned Models		Código / Code
	Servana / Servanne	26686
	Mosaico / Mosaic	05812
	Mármol azul / Blue marble	16138
	Mármol verde / Green marble	16138V
	Mármol arena / Sand marble	16138A
	Byzantino azul / Byzantium blue	26669
	Byzantino verde / Byzantium green	26670





Muros estampados / Patterned Walls		Código / Code
	Lankshire Wall	26687
	Wyndham	26681
	Lexington Wall	26682
	Caribe	26684
	Dacota	26685







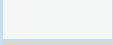

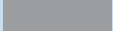
Liners piscina forma Libre / Liners for free form pools

Modelos de Liners para todo tipo de piscinas de formas libres que requieren una **triangulación** para el cálculo de sus dimensiones.

Liner models for all kinds of pool shapes requiring **triangulation** for size calculation.

Modelos lisos / Plain Models		Código / Code
	Azul Claro / Light Blue	16147
	Azul Marino / Navy Blue	16148
	Verde Caribe / Caribbean green	16149
	Blanco / White	16150
	Arena / Sand	16151
	Negro / Black	089094
	Gris / Grey	089090

Modelos estampados / Patterned Models		Código / Code
	Servana / Servanne	26688
	Mosaico / Mosaic	16155
	Mármol azul / Blue marble	16152
	Mármol verde / Green marble	16152V
	Mármol arena / Sand marble	16152A
	Byzantino azul / Byzantium blue	26689
	Byzantino verde / Byzantium green	26690

Muros estampados / Muros estampados		Código / Code
	Lankshire Wall	26692
	Wyndham	26693
	Lexington Wall	26694
	Caribe	26696
	Dacota	26697

Triangulación de una piscina

La triangulación es el único método fiable para calcular las medidas de una piscina, sea cual sea su forma.

A continuación detallamos los pasos a seguir para conseguir las medidas exactas y forma de su piscina.

Pool Triangulation

Triangulation is the only reliable way to calculate pool measurements, regardless of shape.

Below we explain the steps to follow in order to obtain exact measurements and pool shape.

1

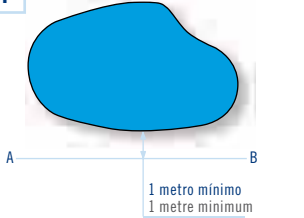

A
B

1 metro mínimo
1 metre minimum

Imagine una línea recta en el exterior de la piscina, señale en sus extremos el punto "A" y el punto "B". La recta debe estar a 1 metro de distancia como mínimo de la piscina.

Imagine a straight line alongside the pool. Mark the ends point A and point B. The straight line must be at least one metre from the pool.

2

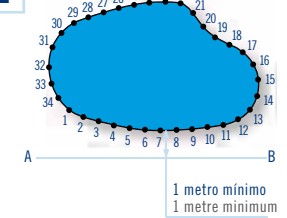

A
B

1 metro mínimo
1 metre minimum

Realice las señales de espacio cada 50 cm y vaya numerándolas como 1,2,3...de forma que cubra la periferia de la piscina.

Space the distance indicators every 50 cm and number them as follows: 1, 2, 3, etc. until the entire edge of the pool has been covered.

3

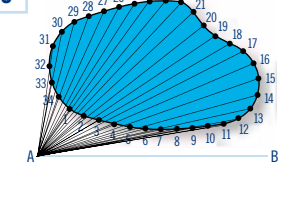

A
B

Medir saliendo del punto "A", la distancia en línea recta con todos los puntos señalados por un número. (ej: distancia "A" y "1", entre "A" y "2" y así sucesivamente).

Starting at point A, measure the distance in a straight line from each point marked by a number (e.g. distance from A to 1, from A to 2 and so on).

4

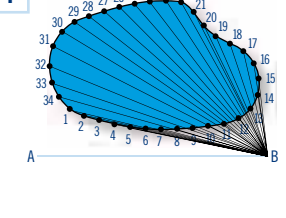

A
B

Proceder de la misma forma saliendo del punto "B".

Do as before from point B.

4

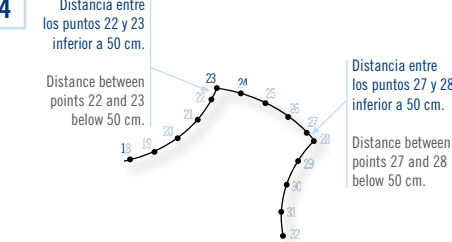

Distancia entre los puntos 22 y 23 inferior a 50 cm.
Distance between points 22 and 23 below 50 cm.

Distancia entre los puntos 27 y 28 inferior a 50 cm.
Distance between points 27 and 28 below 50 cm.

Si la forma de la piscina no es totalmente redondeada, sino que presenta ángulos rectos, es imprescindible añadir un punto. (ver ejemplo de dibujo adjunto).

If the pool is not completely round and forms right angles, it is essential you add a point. (See example drawing).

5

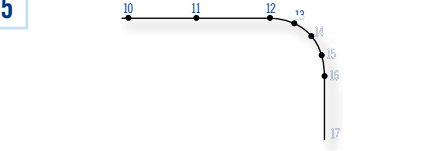

10 11 12 13 14 15 16 17

Cuando las curvas son pequeñas, se tiene que reducir la distancia entre los puntos de manera que se obtenga un mínimo de 3 puntos por arco de círculo.

Sin embargo, sobre las partes de la derecha, se puede aumentar la distancia entre los puntos (ver ejemplo de dibujo adjunto).

When the curves are small, the distance between the points must be reduced so that a minimum of 3 points per arc of circle is obtained. However, for the parts on the right, the distance between the points can be increased (see drawing).

6

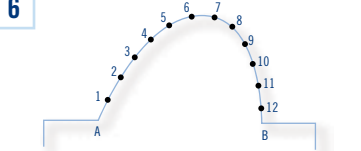

A
B

Para medir una escalera de forma no geométrica, posicionar "A" y "B" en la base de la escalera y proceder de la misma manera que para una triangulación de una piscina de forma libre.

To measure non-geometric steps, place A and B at the base of the steps and proceed as for the triangulation of a free form pool.

Revestimiento liner 75/100

Liner 75/100

Liners para escaleras

Liners for steps

Para una correcta elección del liner de la escalera de la piscina, detallamos a continuación las formas y modelos que puede escoger sobre liners lisos o estampados.

Todos los casos que se expresan a continuación, son para modelos de escaleras de forma **STANDARD**. En el caso de que usted disponga de una escalera **NO STANDARD**, rogamos se pongan en contacto con su proveedor habitual AstralPool

Below we provide you with the details of the shapes and models you can choose from for plain or patterned liners to ensure you select the correct liner for your pool steps.

All the cases described below are for STANDARD shaped steps. If you have NON-STANDARD steps, please contact your regular AstralPool supplier.

Ejemplo de una escalera Standard

Example of standard steps

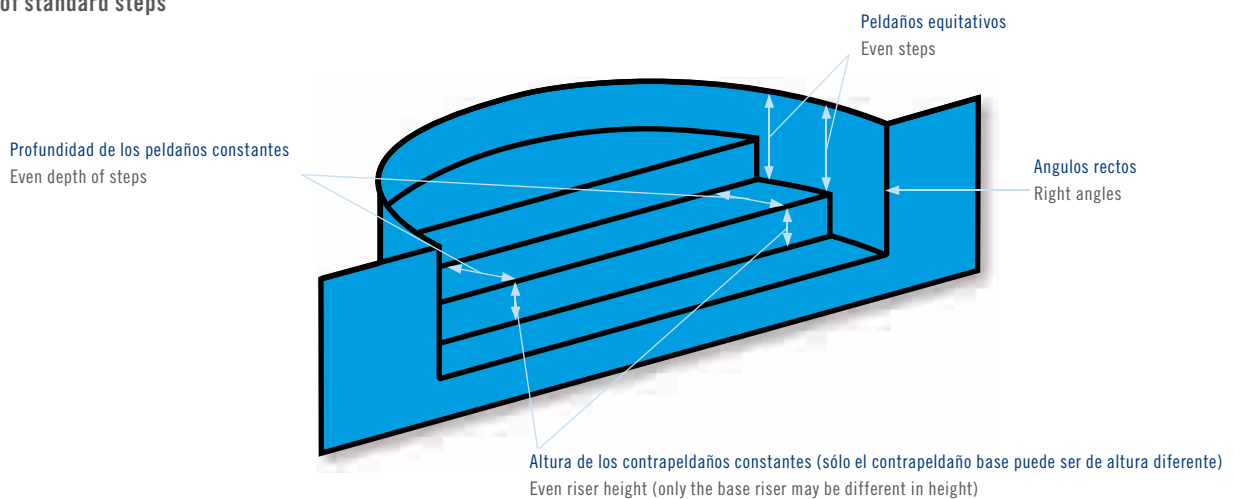

Ejemplo de una escalera No Standard



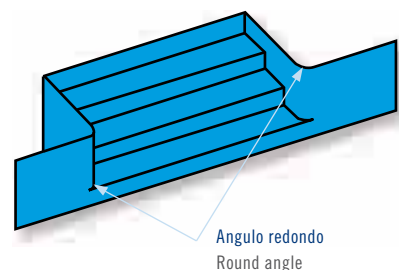
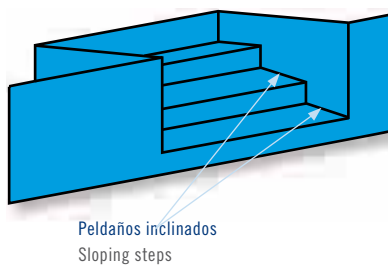
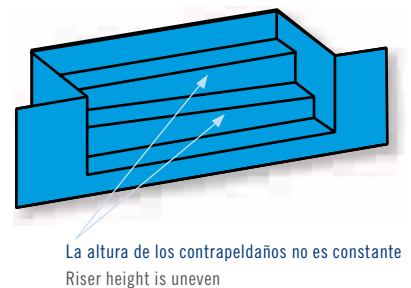

Example of non-standard steps

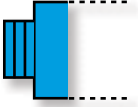

Liners lisos / Liners lisos + Cenefa
Plain Liners / Plain Liners + Frieze borders

Escaleras / Ladders		Liner Liso / Plain Liner	Liner Liso + Cenefa Plain Liner + Frieze borders	Diagrama / Diagram
Forma / Shape	Anchuras / Widths	Código / Code	Código / Code	
Recta Straight	hasta 2 m / up to 2 m	05789	05789B	
	2 / 3 (m)	05790	05790B	
	3 / 4 (m)	05791	05791B	
Romana Roman	hasta 2 m / up to 2 m	16163	16163B	
	2 / 3 (m)	25868	25868B	
	3 / 4 (m)	05800	05800B	
Obliqua Oblique	hasta 2 m / up to 2 m	16164	16164B	
	2 / 3 (m)	16165	16165B	
	3 / 4 (m)	16166	16166B	
Angulo Recto Right Angle	hasta 2 m / up to 2 m	05803	05803B	
	2 / 3 (m)	05804	05804B	
1/4 Circular 1/4 Circular	hasta 2 m / up to 2 m	16167	16167B	
	2 / 3 (m)	089443	089443B	

Liners estampados / Liners estampados + Cenefa
Patterned Liners / Patterned Liners + Frieze borders

Escaleras / Ladders		Liner estampado / Patterned Liner	Liner estampado + Cenefa Patterned Liner + Frieze borders	Esquema / Diagram
Forma / Shape	Anchuras / Widths	Código / Code	Código / Code	
Recta Straight	hasta 2 m / up to 2 m	05794	057848	
	2 / 3 (m)	05795	057958	
	3 / 4 (m)	05796	057968	
Romana Roman	hasta 2 m / up to 2 m	16169	161698	
	2 / 3 (m)	05801	058018	
	3 / 4 (m)	05802	058028	
Obliqua Oblique	hasta 2 m / up to 2 m	16170	161708	
	2 / 3 (m)	16171	161718	
	3 / 4 (m)	16172	161728	
Angulo Recto Right Angle	hasta 2 m / up to 2 m	05806	058068	
	2 / 3 (m)	05807	058078	
1/4 Circular 1/4 Circular	hasta 2 m / up to 2 m	16173	161738	
	2 / 3 (m)	089446	0894468	

Revestimiento liner 150/100

Liner 150/100

El liner de 150/100 (1,5 mm de espesor) está formado por dos films de PVC laminados el uno al otro y reforzado con una trama de poliéster. Esta solidez le comporta que esté especialmente concebido para piscinas colectivas, de uso muy frecuente, rehabilitaciones de piscinas agrietadas...

En el caso de liner 150/100, no viene preparado de fábrica para su colocación. Este se sirve en rollos de 1,65 m. de ancho x 25,2 m. de longitud y el montaje se efectuará "in situ" mediante soldadura térmica o soldadura con disolvente (THF) por un profesional en la piscina.

Características principales:

- Ideal para renovación del revestimiento de piscinas que tengan ya bastantes años, por su facilidad de montaje y bajo coste respecto al arreglo o renovación del gresite o revestimiento standard.
- Nos asegura la plena estanqueidad en piscinas de formas irregulares o piscinas con escaleras de muchos peldaños
- Compatibles con piscinas de hormigón, prefabricadas o de paneles de acero. Igualmente podremos colocarlo en piscinas con rebosadero.



Liner 150/100 (1.5 mm thick) is composed of two PVC films laminated together with a polyester weft. This makes it particularly suited for collective or frequently used pools, rehabilitated cracked pools...

Liner 150/100 comes in 1.65 m wide x 25.2 m long rolls, but is not ready-to-lay. It must be welded into place thermally or with solvent (THF) by a skilled pool technician.

Main specifications:

- Ideal for replacing pool lining because of ease of assembly and low cost in comparison with replacing Gresite tiles or standard cladding.
- Ensures total watertightness in odd shaped pools or pools with numerous steps.
- Compatible with concrete, prefabricated or steel panel pools. Can also be installed in pools with overflow.

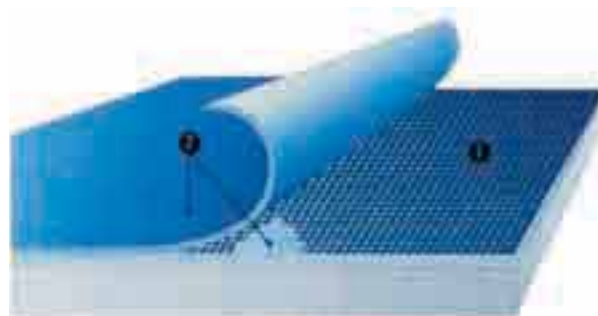

- 1 Fibra armadura interna en tejido de poliéster
Inner frame of polyester weft
- 2 PVC alta resistencia
Highly resistant PVC



Gama de colores liners 150/100

Range of colours for liners 150/100

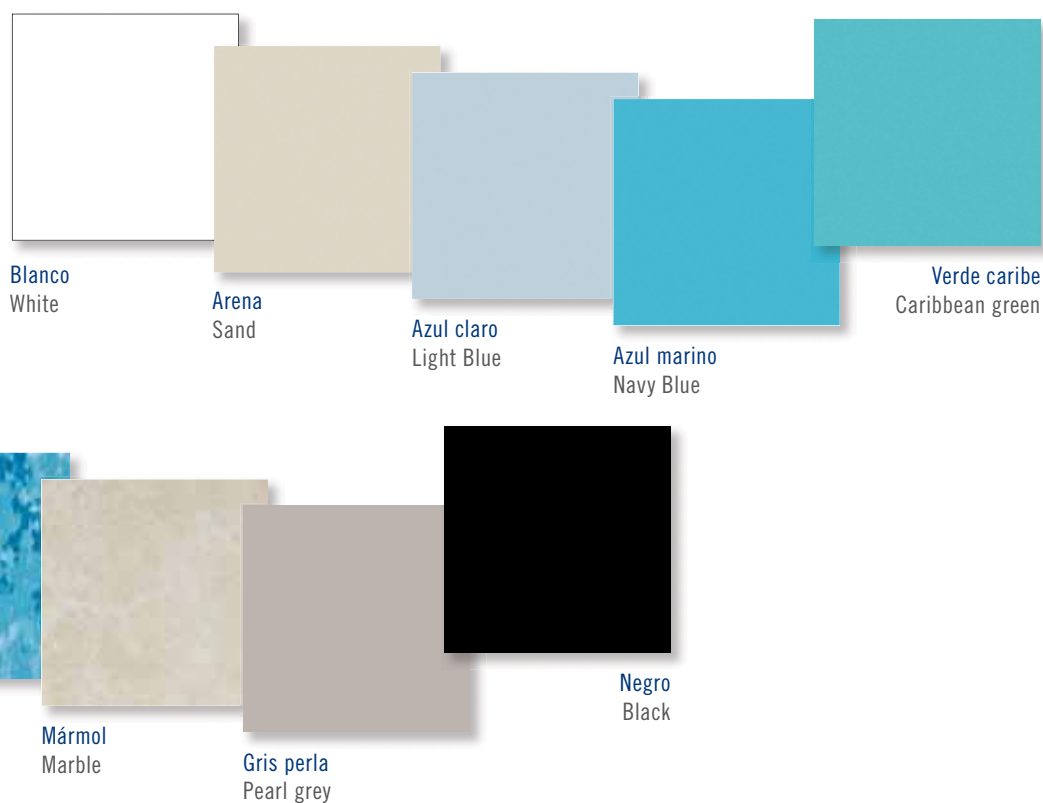

Modelo / Model	Medidas rollo / Rolls size		
	1,40 x 25,2 (m)	1,65 x 25,2 (m)	2,05 x 25,2 (m)
Blanco / White	-	12144	-
Arena / Sand	-	19062	-
Azul claro / Light Blue	12162	12161	17020
Azul marino / Navy Blue	12163	12168	17019
Verde Caribe / Caribbean green	12141	12140	-
Mosaico / Mosaic	-	12165	-
Servanne	-	085105	-
Mármol / Marble	-	23598	-
Gris perla / Pearl Grey	-	23596	-
Negro / Black	-	12231	-

Gama de colores liners antideslizantes 150/100

Range of colours for non-slip liners 150/100

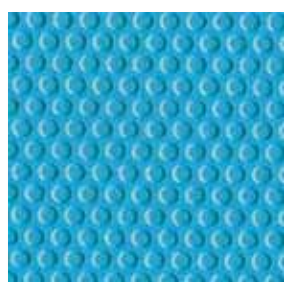

Ejemplo de color con acabado antideslizante
Example of non-slip colour finish

Modelo / Model	Medidas rollo / Rolls Size	Código / Code
Azul marino / Navy Blue	1,65 x 25,2 m	12175
Azul Claro / Light Blue		12178
Blanco / White		23599
Verde Caribe / Caribbean green		12176
Arena / Sand		19726
Gris perla / Pearl grey		23597

Montaje y fijación del liner

Liner assembly and fastening

Montaje del liner

Liner assembly

Antes de iniciar el montaje del liner en nuestra piscina, tenemos que tener en cuenta una serie de aspectos fundamentales para la correcta y larga duración de éste.

- El suelo o superficie sobre el cual se va a colocar el liner debe tener las siguientes propiedades:
 - Ha de ser permeable, para permitir la evacuación de las aguas que se condensan.
 - Ha de ser liso para evitar el deterioro del liner.
 - Igualmente ha de estar libre de todo tipo de materiales incompatibles con la membrana: para el caso del PVC flexible, evitar el caucho, la pintura, los tintes, el alquitrán, el material adhesivo, etc.
 - Ha de estar seco y limpio.
 - En el caso de utilización de una capa separadora, dicha capa debe ser de un material imputrescible (filtro de protección).
- Utilizar exclusivamente el producto de adherencia prescrito por AstralPool.
- Los liners de PVC tienen un coeficiente de dilatación del orden de 0,2% por 10°C. Es preferible efectuar la colocación una temperatura entre 10°C y 25°C.
- Todos los accesorios a utilizar deben llevar una doble junta especial para asegurar la estanqueidad.

Before laying the liner in the pool, we must bear in mind certain basic factors to ensure correct and lasting use.

- The floor or surface where the liner is to be laid, must have the following properties:
 - Must be permeable to ensure removal of condensed water.
 - Must be completely smooth to prevent deterioration.
 - Must also be free of any material that is incompatible with the membrane: for PVC, avoid using rubber, paint, inks, tar or adhesive materials.
 - Must be clean and dry.
 - If a separating layer has been used, it must be rot-proof (protection filter).
- Only use bonding products recommended by AstralPool.
- PVC liners have an expansion coefficient of around 0.2% per 10°C. You are recommended to lay the liner at temperatures between 10°C and 25°C.
- All accessories must have a double special joint to secure the watertightness.



Recomendaciones del Dr. Pool

- Para una correcta colocación del liner y de los accesorios a empotrar (boquillas, skimmers, sumideros, etc), recomendamos que la instalación sea realizada o supervisada por un profesional.

Tips from Dr. Pool

- To ensure that both liner and built-in accessories (nozzles, skimmers, drains, etc) are correctly laid, we recommend that installation be supervised by a pool professional



Sistema de fijación “HUNG” para liners 75/100 Hung type fastening system for liners 75/100

El sistema de fijación varía dependiendo si vamos a instalar el revestimiento liner en una piscina ya construida o una por construir. En ambos casos la fijación es compatible para liners de 75/100 y 150/100.

The fastening system varies depending on whether the liner is to be laid in a pool already built or one yet to be built. In both cases the fastening is compatible for liners of 75/100 and 150/100.

Fijación tipo “HUNG” para piscinas a construir
Hung type fastening for pools to be built

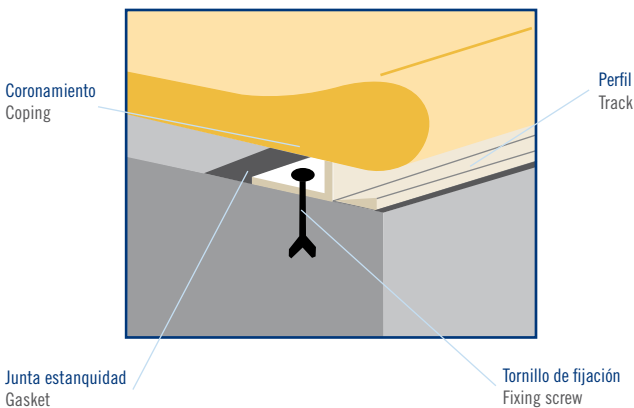

El perfil de sujeción se coloca horizontalmente y centrado a medida en función de la medida de la piscina. Se fijará en el raseado bajo el coronamiento mediante tornillos de fijación cada 20-25 cm. entre si.

The fastening system is placed horizontally and centred to measure according to pool dimensions. It is fixed to the top edge under the coping with fixing screws at intervals of 20-25 cm.

Fijación tipo “HUNG” para renovaciones
Hung type fastening for renovations

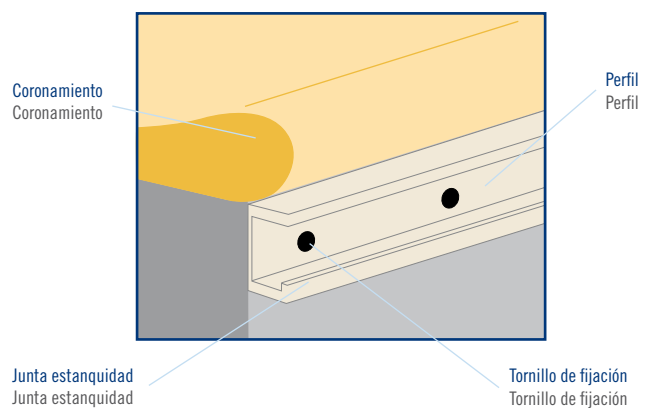

El perfil de sujeción se coloca verticalmente y centrado a medida en función de la medida de la piscina. Se fijará en la pared vertical de la piscina mediante tornillos de fijación cada 20-25 cm. entre si.

The fastening system is placed vertically and centred to measure according to pool dimensions. It is fixed to the vertical wall of the pool under the coping with fixing screws at intervals of 20-25 cm.

Sistemas de fijación “Overlap” y “V” para liners 75/100 Overlap and V fastening systems for liners 75/100

Son los sistemas de fijación mas simples y básicamente están concebidos para **piscinas elevadas de chapa de uso doméstico** que requieren de un liner de 75/100. De rápida y fácil instalación, estos sistemas de fijación son ideales para que el propio usuario pueda instalarse el liner en su piscina.

These are the simplest fastening systems and they have basically been designed for **above ground pools for home use**, requiring a 75/100 liner. Quick and easy to install, these systems are ideal for liner installation by the user.

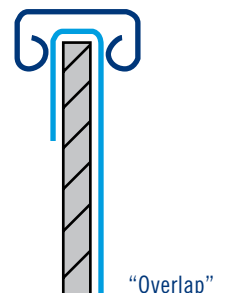

Fijación “Overlap”: tendremos que prever unos 15 cm de liner más para poder realizar correctamente el pinzamiento con el perfil correspondiente. Este se ajusta mediante presión al panel de la piscina.

Overlap fastening: 15 cm of liner is needed for correct insertion into the corresponding track. This is adjusted by applying pressure to the pool panel.

Fijación “V”: el liner viene previsto de un perfil soldado en forma de “V”. Este lo ajustaremos al panel mediante el perfil correspondiente a presión.

V fastening: the liner comes with a V-shaped welded track. This is adjusted to the panel by applying pressure to the corresponding track.

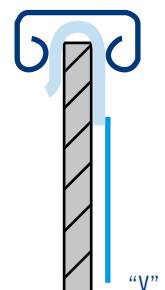

Montaje y fijación del liner Liner assembly and fastening

Además del sistema tradicionalmente utilizado mediante fijación tipo “Hung” mas venda de fijación, el liner 150/100 también podrá ser colocado con chapa plástica en soldadura.

In addition to the traditionally used Hung type fastening plus fixing strip, liner 150/100 can also be laid with welded plastic sheet

Sistema de fijación mediante chapa plástica para liners 150/100 Plastic sheet fastening system for liners 150/100

Fijación para piscinas a construir
Fastening for pools under construction

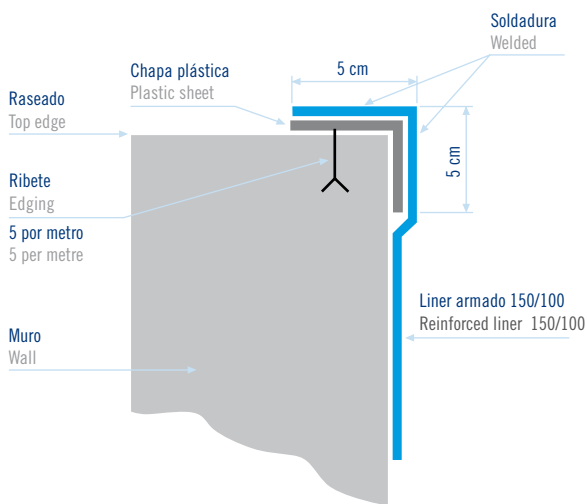

Fijación para renovaciones
Fastening for renovations

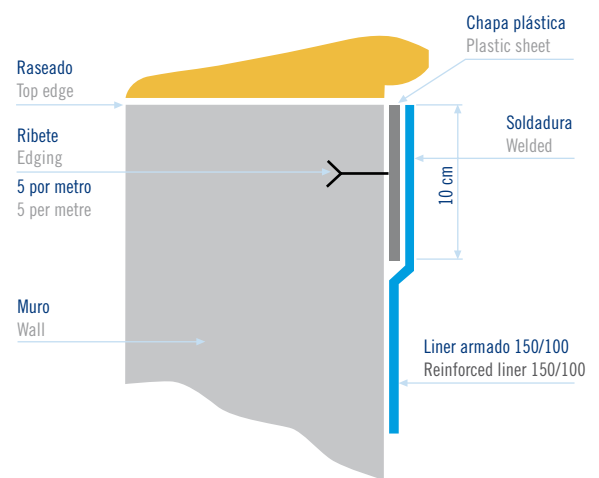

Este sistema está concebido para su utilización en liners de 150/100. El liner se fija a la chapa de acero revestida de PVC laminado en caliente (perfil colaminado) mediante soldadura. Ésta previamente se habrá colocado en la pared vertical, en el caso del sistema de renovación, o encima del raseado, en el caso del sistema de piscinas a construir, por medio de remaches de fijación entorno al perímetro de la piscina.

This system has been designed for use with liners 150/100. The liner is welded to the Stainless Steel sheet coated in thermoplastic. The sheet will have been placed on the vertical wall, for a renovation, or over the top edge, for pools under construction, by fastening rivets around the perimeter of the pool.



Accesorios liner Liner accessories

Accesorios de fijación lineal para liners 75/100 Lineal fastening accessories for liners 75/100



Description / Descripción	Code
For pools to be built / Para piscinas a construir	
Horizontal hung PVC 2 m x 50 mm / Hung horizontal PVC 2 m x 50 mm	05815
Horizontal hung PVC 2 m x 38 mm / Hung horizontal PVC 2 m x 38 mm	09492
Angle PVC radius of 15 cm x 50 mm / Ángulo PVC radio de 15 cm x 50 mm	05819
Angle PVC radius of 15 cm x 38 mm / Ángulo PVC radio de 15 cm x 38 mm	05943
Horizontal hung aluminium 2 m x 50 mm / Hung horizontal aluminio 2 m x 50 mm	05816
Aluminium angle radius 15 cm x 50 mm / Ángulo aluminio radio 15 cm x 50 mm	05818
Fastening rivets (Box of 250 units) / Remaches de sujeción (caja de 250 u.)	05820
Flexible fastening strip. Lineal metre / Tira de sujeción flexible. Metro lineal	05825
For pool renovations / Para renovación de piscinas	
Vertical hung PVC 2 m / Hung vertical PVC 2 m	05817
Angle for vertical fastening (radius 15 cm) / Ángulo para sujeción vertical (radio 15 cm)	16194
Vertical hung aluminium 2 m / Hung vertical aluminio 2 m	16175
Fastening rivets (Box of 250 units) / Remaches de sujeción (caja de 250 u.)	05820
Flexible fastening strip. Lineal metre / Tira de sujeción flexible. Metro lineal	05825

Accesorios liner Liner accessories

Accesorios para liners 150/100 Accessories for liners 150/100

Description / Descripción	Code
Galvanized plate strip (2 x 0,05 m) / Tira de chapa galvanizada (2 x 0,05 m)	087033
Applicator bottle (unit) / Frasco aplicador (unid.)	05780
Band (8 mm) / Venda (8 mm)	05781
Solvent THF (1 litre) / Disolvente THF (1 litro)	05778
Solvent THF (5 litros) / Disolvente THF (5 litros)	05779
Neoprene glue for PVC (5 kg) / Cola neopreno para PVC (5 kg)	05784

Nota: En caso de montar liner de 150/100° mediante fijación tipo Hung con venda de 8 mm, los accesorios serán los mismos que para los liners de 75/100° (ver página anterior).

Note: In the event of assembling a liner 150/100° by hung type fastening with an 8 mm band, the accessories are the same as for liners 75/100° (see previous page).

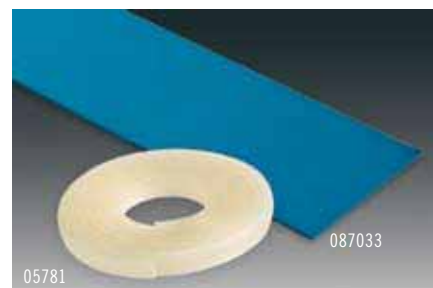

Adhesivos para todo tipo de liner Adhesives for all types of liners

Description / Descripción	Code
Adhesivos para protección antibacterias (bote 5 kg) Adhesive for antibacterial protection (Tin 5 Kg)	05822
Kommerling adhesive 1220 (Tube 125 ml) / Adhesivo Komerling 1220 (tubo 125 ml)	06655
Kommerling adhesive 1220 (Tin 750 ml) / Adhesivo Komerling 1220 (bote 750 ml)	06656



Protección para todo tipo de liner Protection for all types of liners

Description / Descripción	Code
Protección 300 gr/m² AB azul (rollo 100 m²) Protection 300 gr/m² AB blue (Roll 100 m²)	16176
Protección 300 gr/m² AB azul (rollo 50 m²) Protection 300 gr/m² AB blue (Roll 50 m²)	26702



Nos reservamos el derecho de cambiar total o parcialmente las características de nuestros artículos o el contenido de este documento sin previo aviso.
We reserve the right to change all or part of the features of the articles or contents of this document, without prior notice.

